

Spectroscopy

## Features and Benefits

- **Pre-aligned, pre-calibrated detector & spectrograph**

Motorized, individually factory-calibrated systems – out-of-the-box operation and seamless integration to experimental set-ups

- **USB 2.0 interface**

Plug and play connectivity, ideal for laptop operation alongside Andor USB cameras

- **Motorized, indexed triple grating turret**

Easily upgradable in-the-field

- **Dual detector outputs**

For extended wavelength coverage when combining Andor UV-Visible CCD and InGaAs cameras  
Compatible with Andor's range of CCD, ICCD & EMCCD cameras

- **Multi-track enhanced option**

Optimizes system performance for low cross-talk, high density multi-leg fibre signal acquisition

- **Wide range of accessories available**

The ultimate in modular set-up and in-field upgradability, including:

- Motorized slits & filter wheel
- Microscope interfaces
- Shutters
- Fibre-optic & lens couplers
- Multi-way fibre-optic bundles
- Light sources and optics

- **Monochromator capabilities**

Extract best optical resolution while allowing use of single point detectors with sensitivity up to 12  $\mu\text{m}$

- **Silver-protected coated optics options**

Most efficient for Near-Infrared detection when used in conjunction with Andor InGaAs cameras and single point detectors InGaAs, PbS, InSb & MCT

## High resolution performance spectrograph

The Shamrock 750 offers the highest resolution of the Shamrock family, but is also well suited for applications requiring multi-track capabilities. This rugged platform features a comprehensive range of light coupling accessories and gratings, and combines ideally with Andor's market leading CCD, Electron Multiplying CCDs, InGaAs and Intensified CCDs. Andor's latest addition of single point detectors for scanning monochromator applications up to the LWIR (12  $\mu\text{m}$ ) enhances even further the capabilities of this system. State-of-the-art Solis Spectroscopy and Solis Scanning software offer a dedicated and intuitive interfaces for spectrograph, detectors and motorized accessory control as well as easy detection parameter set-up.

## Specifications Summary

|   |  |
|---|--|
| <b>Resolution with Newton DU940 CCD</b>         |  |
| 1200 l/mm @ 500 nm                              | 0.04 nm  |
| 2400 l/mm @ 300 nm                              | 0.02 nm  |
| <b>Aperture</b>                                 | F/9.7  |
| <b>Focal Length</b>                             | 750 mm   |
| <b>Magnification (Vertical @ centre of CCD)</b> | 1  |
| <b>Gratings</b>                                 | Interchangeable indexed triple turret          |
| <b>Slit width range (input/output)</b>          | Manual or Motorized 10 $\mu\text{m}$ to 2.5 mm |
| <b>Communication</b>                            | USB 2.0  |
| <b>Wavelength Accuracy</b>                      | 0.03 nm  |
| <b>Wavelength Repeatability</b>                 | 10 pm  |

## Step-by-Step System Configuration

How to customize the Shamrock 750:

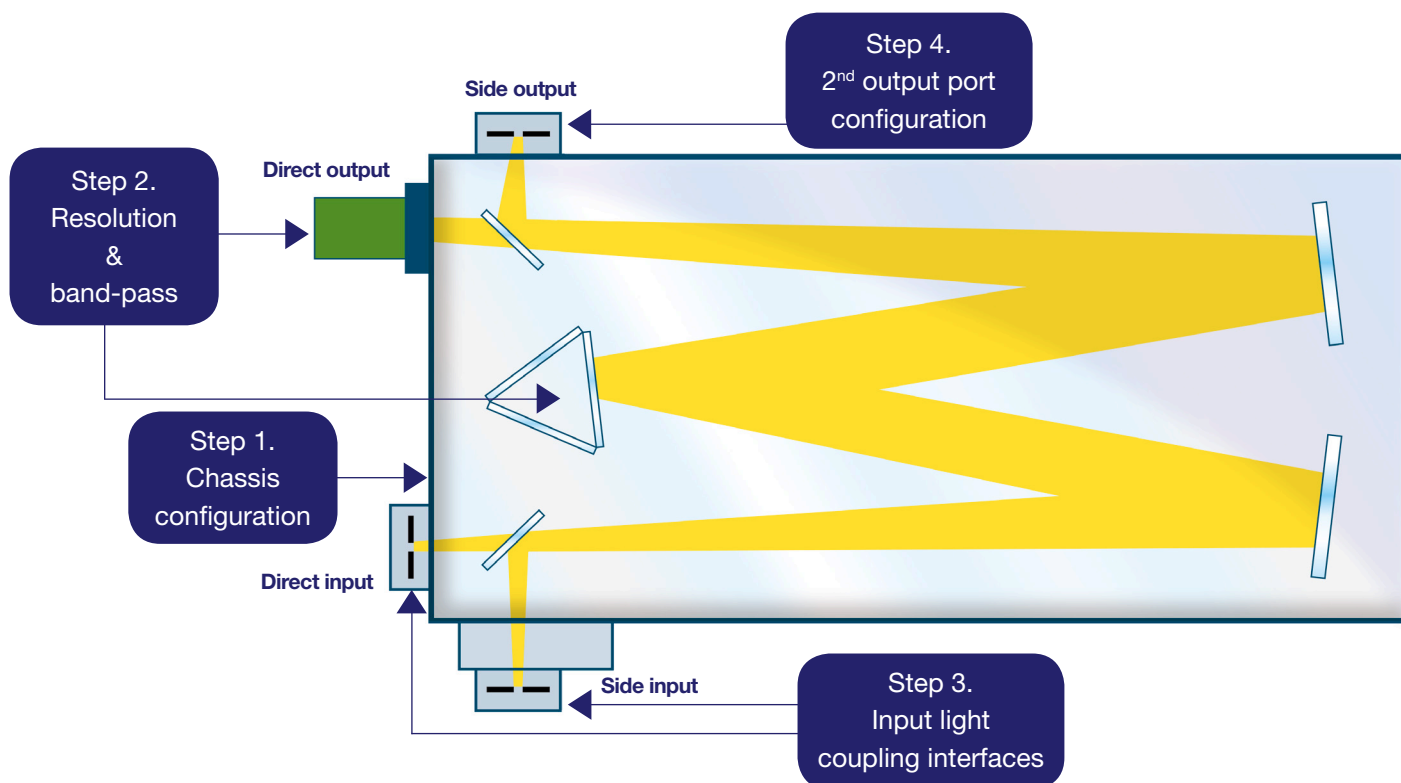

### Step 1. - Chassis configuration

- Select combination of input and output ports (see page 3 for available options).
- Select type of optics coating required (aluminium + MgF<sub>2</sub> is standard, protected silver coated optics available on request for NIR detection).
- Select purge port option (for improved detection down to 180 nm), and shutter for background acquisition and detectors protection.

### Step 2. - Resolution & band-pass

- Select the appropriate Shamrock spectrograph platform, giving due consideration to bandpass and spectral range requirement.
- Select gratings and detector to fulfil resolution requirements.
- Select gratings for suitable wavelength coverage.

### Step 3. - Input light coupling interface

Refer to accessory tree for available configurations (direct coupling, fibre coupling or 3<sup>rd</sup> party hardware connectivity).

### Step 4. - 2<sup>nd</sup> exit port configuration

Refer to accessory tree for available configurations, including camera flanges.

### Step 5. - Software interface

Select either state-of-the-art Solis software or Software Development Kit (SDK) option – please refer to appropriate section for further information.

## Step 1 - Chassis Configuration

### Ordering Information

| Model        | Side input port  | Direct input port | Direct output port | Side output port | Motorized flipper mirror |
|--------------|--|-------------------|--------------------|------------------|--------------------------|
| SR-750-A     | Manual slit  | -                 | Camera             | -                | -                        |
| SR-750-B1    | Manual slit  | -                 | Camera             | Manual slit      | ✓                        |
| SR-750-B2    | Manual slit  | -                 | Camera             | Camera           | ✓                        |
| SR-750-C     | Manual slit  | Manual slit       | Camera             | -                | ✓                        |
| SR-750-D1    | Manual slit  | Manual slit       | Camera             | Manual slit      | ✓                        |
| SR-750-D2    | Manual slit  | Manual slit       | Camera             | Camera           | ✓                        |
| SR-750-X-SIL | Protected silver coated optics options for models shown above (replace X with relevant model number) |                   |                    |                  |                          |

### Optics Coatings Reflectivity Graph

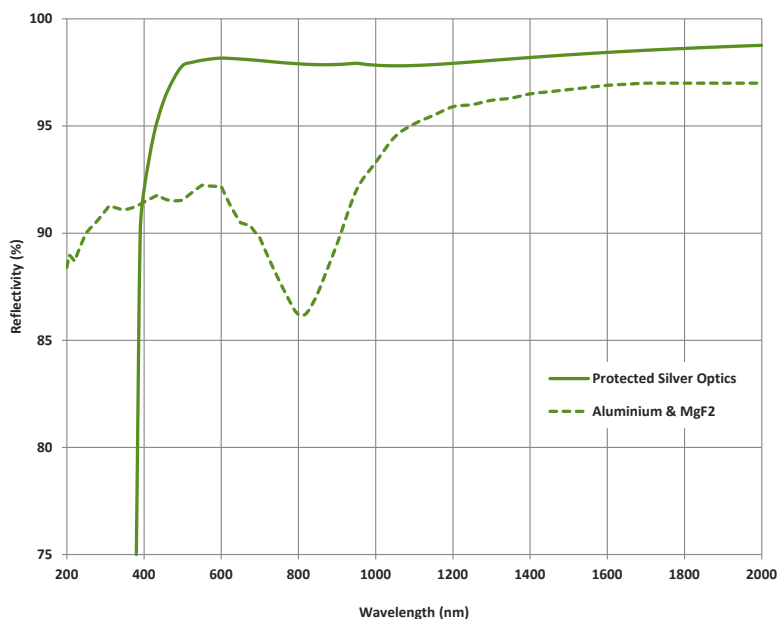

The graph shows the standard Al + MgF<sub>2</sub> optics coatings reflection efficiency versus wavelengths.

Protected silver coated optics option is also available on request for maximum efficiency in the NIR region and is recommended for working with Andor iDus InGaAs detectors or IR single-point detectors, such as MCT, PbS and InSb.

When choosing protected silver coatings, it is strongly recommended to also order **protected silver coated gratings** for maximum efficiency throughout the system.

### Chassis Accessories

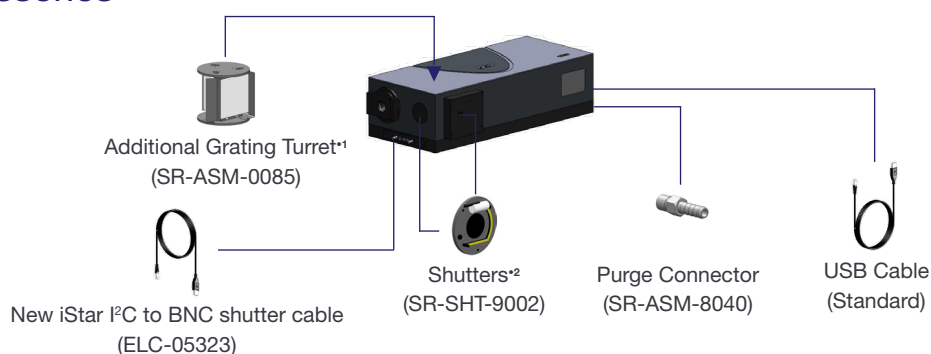

## Step 2a - Choosing The Right Platform vs Dispersion Requirements



Resolution calculator

[andor.com/calculators](https://andor.com/calculators)

**Green**

Aberration-free region

**Orange**

Possible impact on system resolution

**Red**

Likely impact on system resolution

Czerny-Turner spectrographs are designed to provide the best optical performance for a range of grating angles as reflected on the green parts of the graph above. Outside this range, the spectral lines may exhibit a degree of optical aberration (such as coma), which will become more prominent at the steeper angles. These configurations are reflected by the orange to red scales on the graph. In these regions, consideration should be given to higher spectrograph focal length models with lower groove density gratings to achieve the desired resolution.

|                                 | Grating (l/mm) |      |      |      |             |                    |
|---------------------------------|----------------|------|------|------|-------------|--------------------|
|                                 | 150            | 300  | 600  | 1200 | 1800 (Holo) | 2400 (Holo)        |
| <b>Shamrock 193</b>             |                |      |      |      |             |                    |
| Bandpass (nm) <sup>*3,4,5</sup> | 902            | 445  | 215  | 98   | 56          | 46 <sup>*6</sup>   |
| Resolution (nm) <sup>*4,5</sup> | 1.96           | 0.96 | 0.47 | 0.21 | 0.12        | 0.10 <sup>*6</sup> |
| <b>Shamrock 303i</b>            |                |      |      |      |             |                    |
| Bandpass (nm) <sup>*3,4,5</sup> | 600            | 297  | 144  | 67   | 39          | 32 <sup>*6</sup>   |
| Resolution (nm) <sup>*4,5</sup> | 0.88           | 0.43 | 0.21 | 0.10 | 0.06        | 0.05 <sup>*6</sup> |
| <b>Shamrock 500i</b>            |                |      |      |      |             |                    |
| Bandpass (nm) <sup>*3,4,5</sup> | 357            | 177  | 86   | 40   | 26          | 19 <sup>*6</sup>   |
| Resolution (nm) <sup>*4,5</sup> | 0.52           | 0.26 | 0.13 | 0.06 | 0.04        | 0.03 <sup>*6</sup> |
| <b>Shamrock 750</b>             |                |      |      |      |             |                    |
| Bandpass (nm) <sup>*3,4,5</sup> | 242            | 120  | 59   | 28   | 18          | 14 <sup>*6</sup>   |
| Resolution (nm) <sup>*4,5</sup> | 0.35           | 0.18 | 0.09 | 0.04 | 0.03        | 0.02 <sup>*6</sup> |

Where aberration is a concern for a particular experimental set-up, the table above shows resolution and band-pass performance for a variety of alternative configurations. This should be used in conjunction with the graph above to assist in selecting the most appropriate Shamrock spectrograph platform to meet resolution and band-pass needs, whilst minimising the risk of potential aberration.

## Step 2b - Choosing The Right Grating vs Resolution & Band-pass

The Shamrock 750 features an innovative triple grating turret, designed to offer flexibility and control over your choice and interchange of gratings. The triple grating turret can be easily and speedily removed, and replaced by an alternative turret with new gratings. The intelligent design of the 750 means that only a simple offset adjustment is required once the new turret and gratings are added. The 750 is shipped with the grating turret already in place, ensuring your system is ready for use straight out of the box. Additional grating turrets are available with up to three pre-installed gratings (see below for details). If the grating you require is not on the list, please contact Andor for further details. Additional grating turrets (part number SR-ASM-0085) can also be supplied on request.



| Lines/mm | Blaze (nm)                    | Nominal dispersion (nm/mm) <sup>*7</sup> | Bandpass (nm) <sup>*3,*7</sup> | Resolution (nm) <sup>*4,*7,*10</sup> | Peak efficiency (%) | Andor part number  | Maximum recommended wavelength (nm) | Maximum attainable wavelength (nm) |
|----------|-------------------------------|--|--------------------------------|--------------------------------------|---------------------|--------------------|-------------------------------------|------------------------------------|
| 150      | 300                           | 8.78                                     | 243                            | 0.36                                 | 72                  | SR5-GRT-0150-0300  | 6995                                | 11440                              |
| 150      | 500                           | 8.76                                     | 242                            | 0.35                                 | 73                  | SR5-GRT-0150-0500  |                                     |                                    |
| 150      | 800                           | 8.72                                     | 241                            | 0.35                                 | 80                  | SR5-GRT-0150-0800  |                                     |                                    |
| 150      | 1250                          | 8.66                                     | 240                            | 0.35                                 | 84                  | SR5-GRT-0150-1250  |                                     |                                    |
| 150      | 2000                          | 8.53                                     | 236                            | 0.35                                 | 88                  | SR5-GRT-0150-2000  |                                     |                                    |
| 300      | 300                           | 4.38                                     | 121                            | 0.18                                 | 88                  | SR5-GRT-0300-0300  | 3500                                | 5720                               |
| 300      | 500                           | 4.35                                     | 120                            | 0.18                                 | 81                  | SR5-GRT-0300-0500  |                                     |                                    |
| 300      | 1000                          | 4.27                                     | 118                            | 0.17                                 | 72                  | SR5-GRT-0300-1000  |                                     |                                    |
| 300      | 1200                          | 4.23                                     | 117                            | 0.17                                 | 92                  | SR5-GRT-0300-1200  |                                     |                                    |
| 300      | 1700                          | 4.11                                     | 114                            | 0.17                                 | 89                  | SR5-GRT-0300-1700  |                                     |                                    |
| 600      | 300                           | 2.17                                     | 60                             | 0.09                                 | 84                  | SR5-GRT-0600-0300  | 1750                                | 2860                               |
| 600      | 500                           | 2.13                                     | 59                             | 0.09                                 | 72                  | SR5-GRT-0600-0500  |                                     |                                    |
| 600      | 1000                          | 2.01                                     | 56                             | 0.08                                 | 72                  | SR5-GRT-0600-1000  |                                     |                                    |
| 600      | 1200                          | 1.95                                     | 54                             | 0.08                                 | 88                  | SR5-GRT-0600-1200  |                                     |                                    |
| 600      | 1900<br>(@1600) <sup>*8</sup> | 1.64<br>1.79                             | 45<br>49                       | 0.07 <sup>*9</sup><br>0.07           | 88                  | SR5-GRT-0600-1900  |                                     |                                    |
| 1200     | 300                           | 1.06                                     | 29                             | 0.04                                 | 72                  | SR5-GRT-1200-0300  | 875                                 | 1430                               |
| 1200     | 500                           | 1.01                                     | 28                             | 0.04                                 | 81                  | SR5-GRT-1200-0500  |                                     |                                    |
| 1200     | 1000                          | 0.79                                     | 22                             | 0.03 <sup>*9</sup>                   | 69                  | SR5-GRT-1200-1000  |                                     |                                    |
| 1200     | (@ 800) <sup>*8</sup>         | 0.89                                     | 25                             | 0.04                                 | 69                  |                    |                                     |                                    |
| 1200     | Holographic<br>(500 nm peak)  | 1.00                                     | 28                             | 0.04 <sup>*9</sup>                   | 81                  | SR5-GRT-1200-EH*   |                                     |                                    |
| 1800     | Holographic<br>(250 nm peak)  | 0.69                                     | 19                             | 0.03                                 | 62                  | SR5-GRT-1800-DH    | 585                                 | 955                                |
| 1800     | Holographic<br>(380 nm peak)  | 0.66                                     | 18                             | 0.03                                 | 70                  | SR5-GRT-1800-FH    |                                     |                                    |
| 2400     | 300                           | 0.49                                     | 13                             | 0.02                                 | 68                  | SR5-GRT-2400-0300  | 435                                 | 715                                |
| 2400     | Holographic<br>(220 nm peak)  | 0.51                                     | 14                             | 0.02                                 | 68                  | SR5-GRT-2400-BH    |                                     |                                    |
| 2400     | Holographic<br>(400 nm peak)  | 0.45                                     | 12                             | 0.02                                 | 73                  | SR5-GRT-2400-GH    |                                     |                                    |
| Mirror   | UV-VIS                        | -  | -                              | -                                    | -                   | SR5-GRT-MR-AL-MGF2 | -                                   | -                                  |
| Mirror   | VIS-NIR                       | -  | -                              | -                                    | -                   | SR5-GRT-MR-SILVER  | -                                   | -                                  |

\*Option for minimized scattered light.

**Need to have maximum collection efficiency in the NIR/SWIR?** All gratings are also available with protected silver coating. Please contact your local representative for further information.

## Step 2c - Selecting The Correct Grating Efficiency Option

All graphs shown below represent efficiency for 45° polarisation

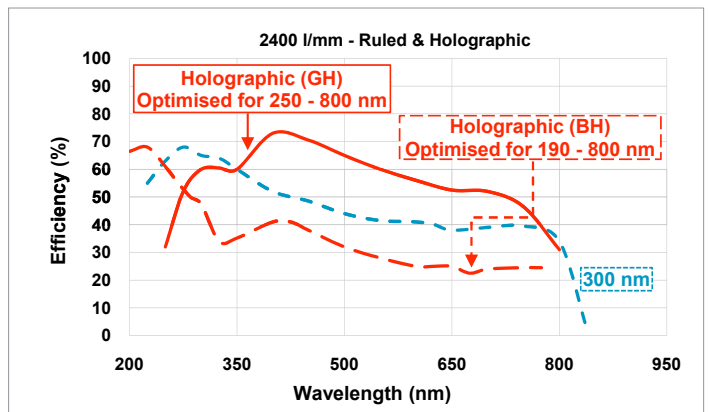
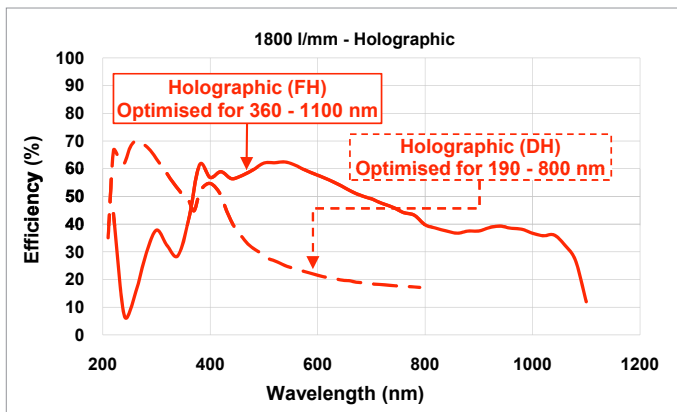
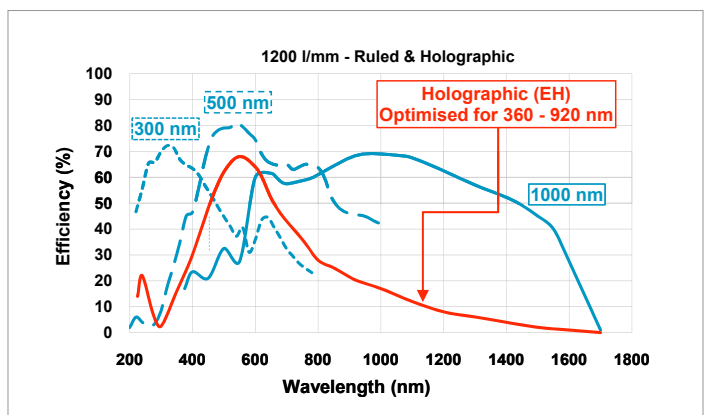
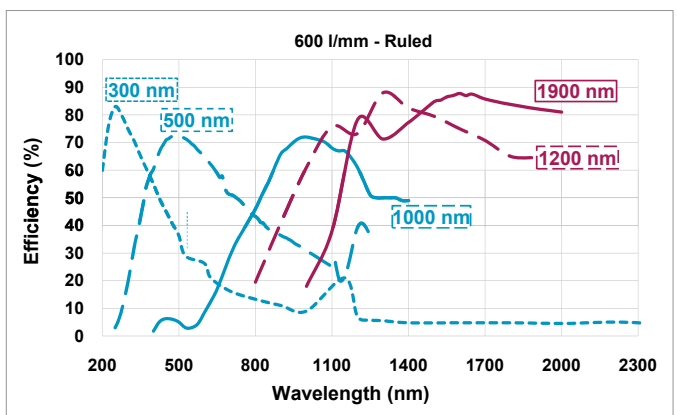
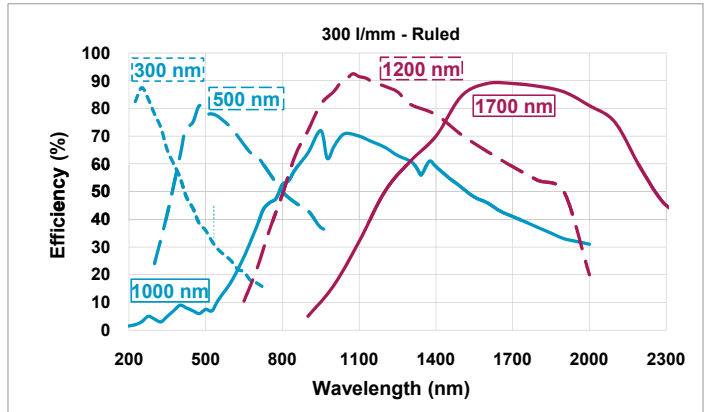
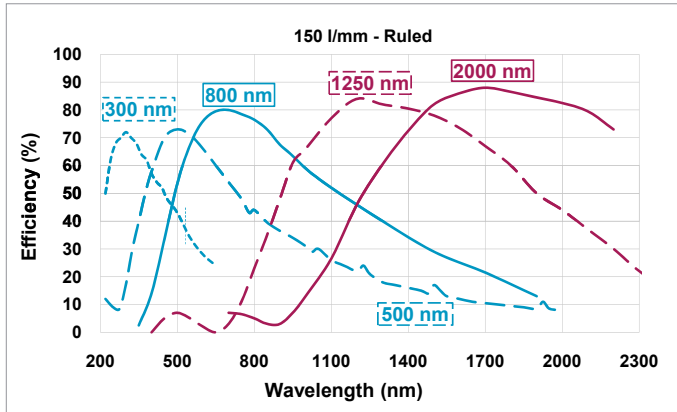

## Important Consideration

System throughput is dependent on the grating's angle of operation and may decrease with higher grating operating angles.



## Step 3 - Selecting The Correct Light Coupling Interfaces

How to customize the Shamrock 750 (Side Entrance Port):

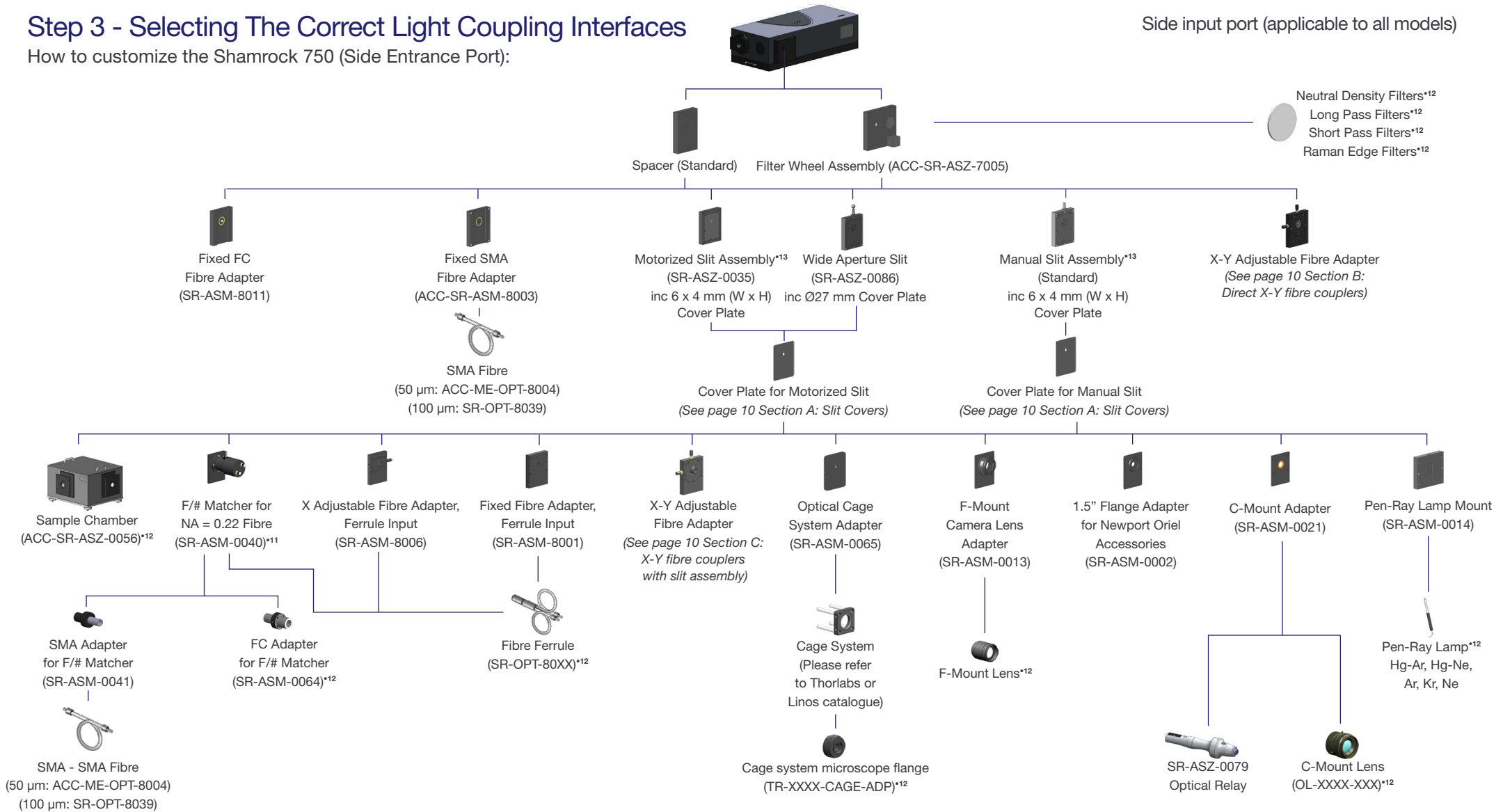

## Step 3 - Selecting The Correct Light Coupling Interfaces

How to customize the Shamrock 750 (Direct Entrance Port):



Direct input port (applicable to C & D models)

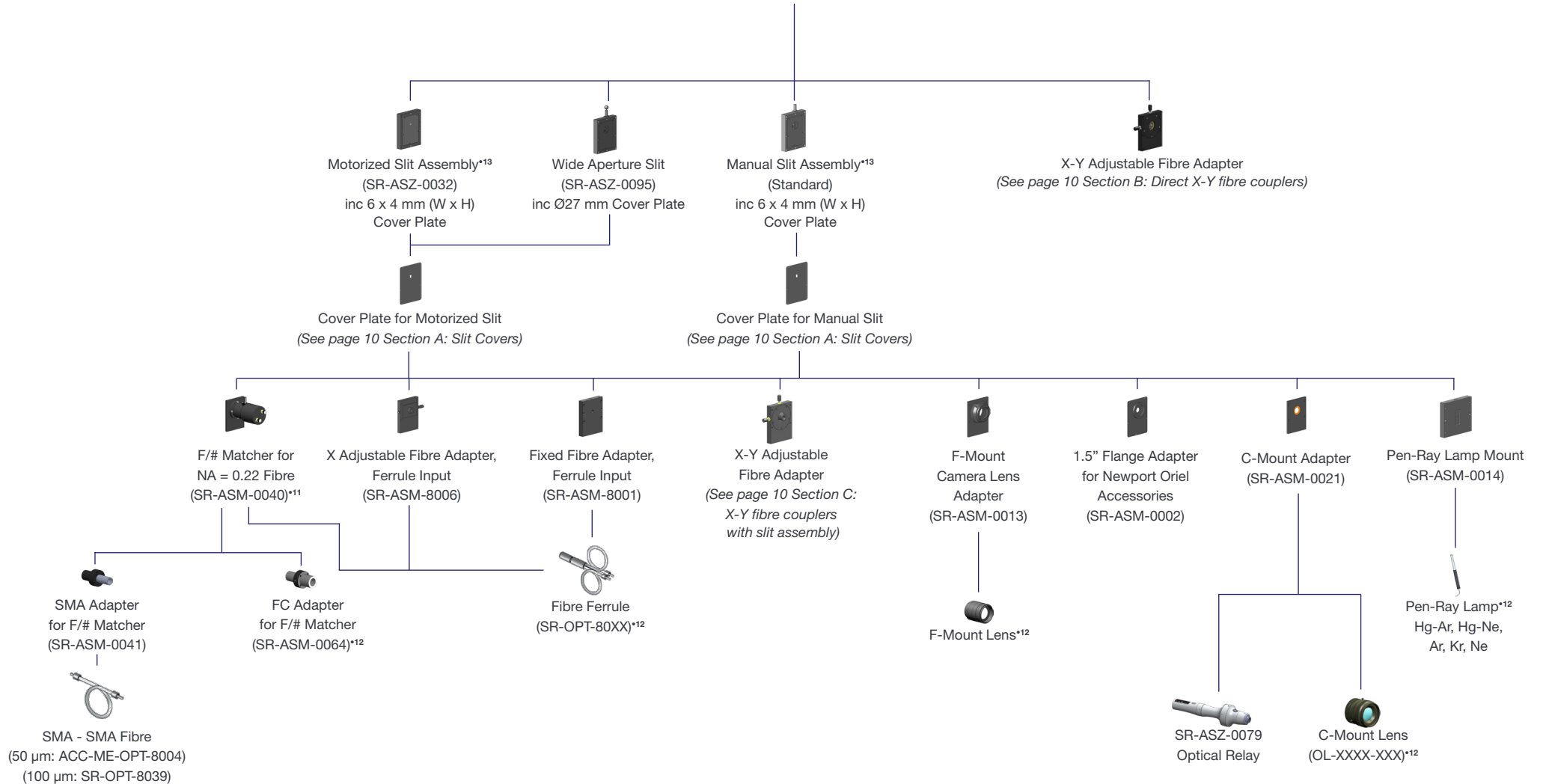



## Step 4 - Cameras & Output Port Flanges

How to customize the Shamrock 750:

Side Output Port (Applicable to B & D models)

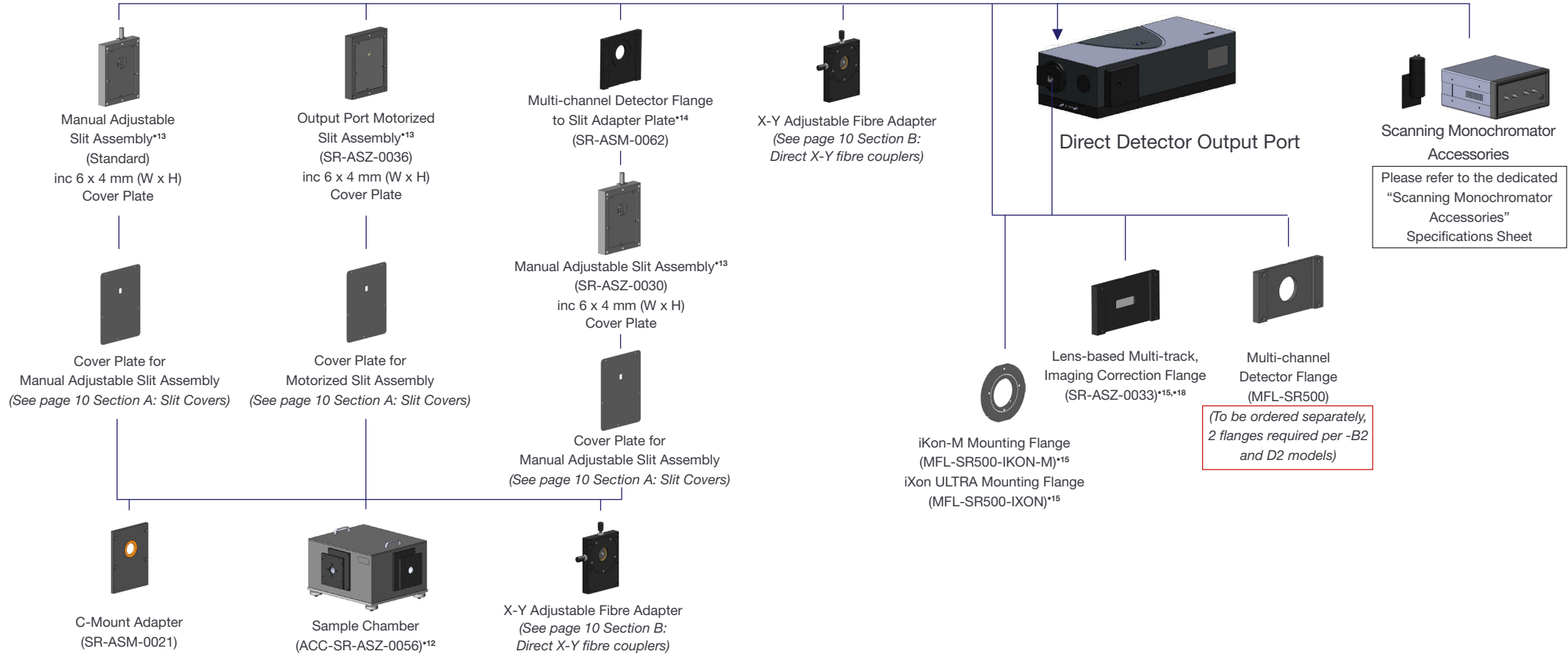

## A: Slit Covers

Cover Plate Apertures for Motorized Slit

| Part No.       | Size              |
|----------------|-------------------|
| SR-ASM-0016*16 | 6 x 4 mm (W x H)  |
| SR-ASM-0017    | 6 x 6 mm (W x H)  |
| SR-ASM-0010    | 6 x 8 mm (W x H)  |
| SR-ASM-0011    | 6 x 14 mm (W x H) |
| SR-ASM-0015*17 | Ø 15 mm           |

Cover Plate Apertures for Manual Slit

| Part No.       | Size              |
|----------------|-------------------|
| SR-ASM-0025    | 6 x 4 mm (W x H)  |
| SR-ASM-0026    | 6 x 6 mm (W x H)  |
| SR-ASM-0027    | 6 x 8 mm (W x H)  |
| SR-ASM-0028    | 6 x 10 mm (W x H) |
| SR-ASM-0029*16 | 6 x 14 mm (W x H) |
| SR-ASM-0067*17 | Ø 15 mm           |

## B: Direct X-Y Fibre Couplers

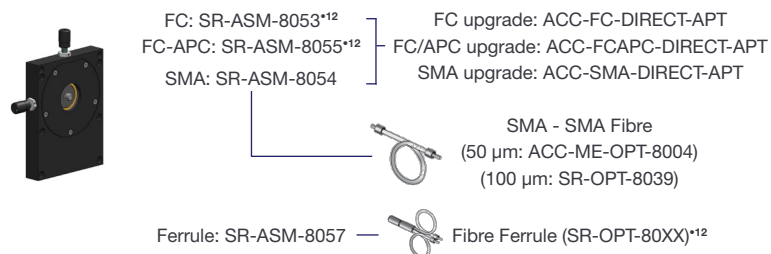

## C: X-Y Fibre Couplers (with Slit Assembly)

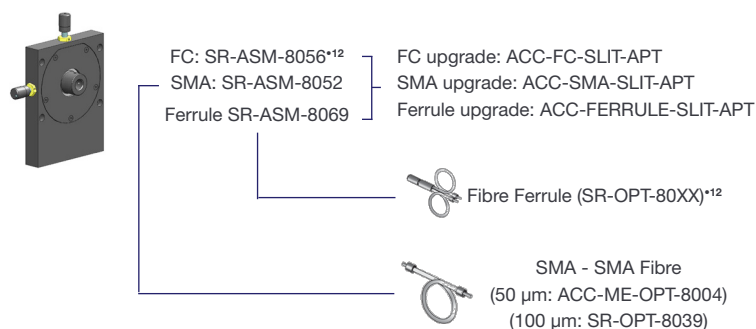

### Notes:

- For connection to manual slits, please also order Ø15 mm slit cover plate SR-ASM-0067
- For connection to motorized slits, please also order Ø15 mm slit cover plate SR-ASM-0015

## Step 5 - Selecting A Software Option

The Shamrock 750 requires at least one of the following software options:

**1 - Solis Spectroscopy** A 32-bit and fully 64-bit enabled application for Windows (XP, Vista, 7 and 8) offering rich functionality for data acquisition and processing, as well as Andor cameras, spectrograph and motorized accessories simultaneous control. AndorBasic provides macro language control of data acquisition, processing, display and export.

**2 - Standalone Solis Spectroscopy** GUI for standalone spectrograph operation

**3 - Andor SDK** software development kit that allows you to control the Andor range of Shamrock spectrographs from your own application. Compatible as 32 bit libraries for Windows (XP, Vista 7 and 8). Compatible with C/C++, C#, VB6 and LabVIEW and Linux.

**4 - Solis Scanning** Dedicated interface for scanning monochromator acquisitions, including comprehensive experimental set-ups builder. Simultaneous control of single point detector Shamrock monochromator and motorized accessories.

## Solis Spectroscopy: Dedicated spectroscopy acquisition software

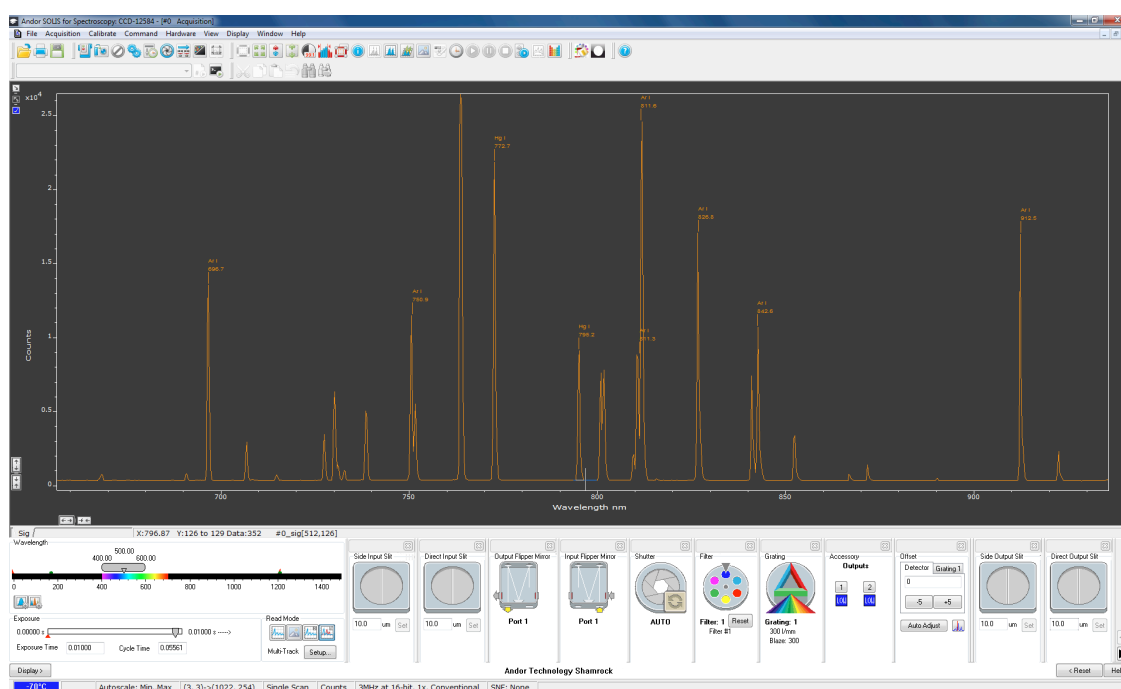

### Wavelength drive

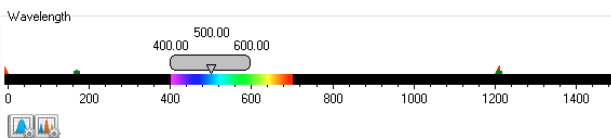

Set the wavelength range for the current grating - drag slider to desired wavelength or just type in appropriate value

### Exposure time

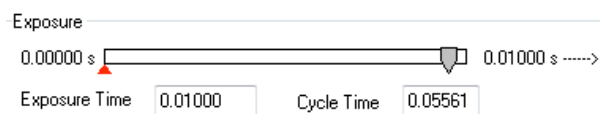

Set the exposure time for the detector - quick access for easy acquisition optimization

### Real Time Control

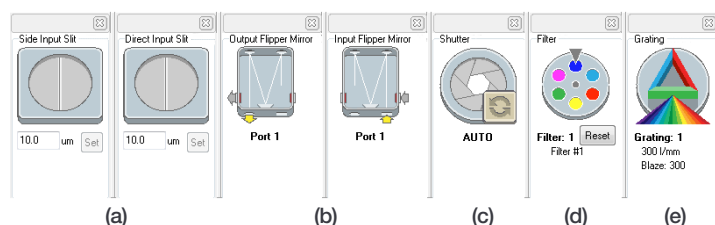

(a) Slit drive: Control the spectrograph slit width - drag blades on icon or type in required slit width

(b) Flipper motor: Used to select the appropriate exit port

(c) Shutter: Synchronization mode selection for shutter operation

(d) Filter wheel: Used to select a particular filter on the filter wheel - just click on the desired filter position

(e) Grating turret: Used for setting grating turret to a new position and bringing desired grating in the optical path - just click on the desired grating

## Product Drawings

Dimensions in mm [inches]

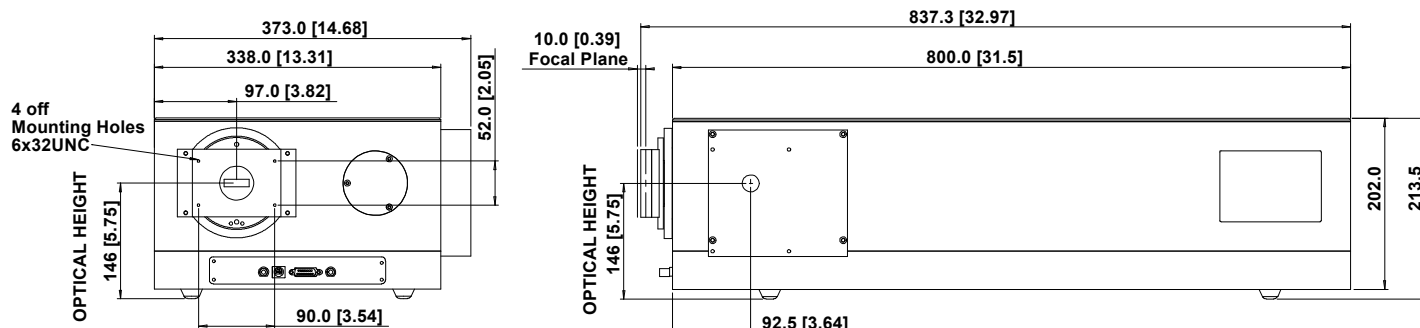
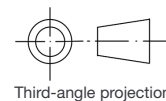

### Optical Axis

The optical path height is shown with standard feet attached.

Weight: 35 kg [77.16 lbs approx]

### Screw Type Requirements

|                                   |                                       |
|-----------------------------------|---------------------------------------|
| CCD flange to Spectrograph flange | 4 off, M4 x 16                        |
| Camera to CCD flange              | 4 off, M3 x 10                        |
| iXon camera to iXon flange        | 4 off, M5 x 10, countersunk, hex head |

## Connecting to the Shamrock 750

### USB Shamrock Control

Connector type: USB 'B' type

### Shutter Control

Connector type: BNC Female, 50 Ω

## Applications Guide

- Absorption-Transmission-Reflection
- Raman (Stimulated, Resonance, CARS, SERS, SORS, TERS)
- Fluorescence-Luminescence
- Single Molecule Spectroscopy
- Plasma Studies & LIBS
- Plasmonics

## Shutter Specifications

|                         |                         |
|-------------------------|-------------------------|
| Maximum repetition rate | 2 Hz                    |
| Minimum open/close time | 15 ms                   |
| Minimum lifetime        | Better than 100K cycles |

## Optical Property

|                                      |                        |
|--------------------------------------|------------------------|
| Focal plane size (mm, W x H)         | 30 x 14                |
| Stray light *19                      |                        |
| <i>FVB (1 nm from laser)</i>         | 1.1 x 10 <sup>-4</sup> |
| <i>FVB (10 nm from laser)</i>        | 2.6 x 10 <sup>-5</sup> |
| <i>1 mm strip (1 nm from laser)</i>  | 1.1 x 10 <sup>-4</sup> |
| <i>1 mm strip (10 nm from laser)</i> | 2.6 x 10 <sup>-5</sup> |

## Wavelength Drive Performance

|  |         |
|--|---------|
| Wavelength accuracy *20<br><i>Center</i> | 0.03 nm |
| Wavelength repeatability *21             | 10 pm   |

## Wavelength Side Accuracy

|                              |         |
|------------------------------|---------|
| Wavelength side accuracy *22 | 0.08 nm |
|------------------------------|---------|

## Multi-track Capabilities

Imaging, or multi-track, refers to the ability - in the context of a spectrograph - to isolate a series of individual, vertically-stacked spectrum channels with minimum cross-talk.

Czerny-Turner spectrographs are based on off-axis imaging, which introduces distortion at the output focal plane due to aberrations. The introduction of toroidal optics to correct for these aberrations is common for instrument with shorter focal length, i.e. below 600 mm. These 'imaging' correction optics effectively pull together the focal plane of best spectral and best spatial resolutions, known respectively as the tangential and sagittal planes.

However, greater focal length spectrographs, such as Shamrock 750, are principally used for very high spectral resolution from a single spectrum. These instruments are therefore based on classical spherical mirrors and lead to some elongation of the signal in the vertical/imaging axis as shown on Figure 1a, hence limiting stacking of multiple spectral channels.

Andor's optional accessory, SR-ASZ-0033, allows correction of the optical line elongation as shown on Figure 1b, whilst maintaining the spectral resolution performance of the system. Moreover, this accessory introduces a demagnification of around 0.75 therefore increasing the possible density of tracks in the vertical/imaging direction.

Figure 2 illustrates this optical improvement through the use of a broadband source, showing the well-defined narrow channels with minimum cross-talk.

Please contact your local sales representative for further information on high-density, multi-channel fibre-optics.

## Typical Setup - Spectroscopy

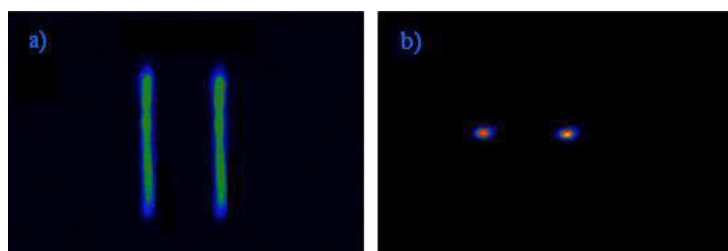
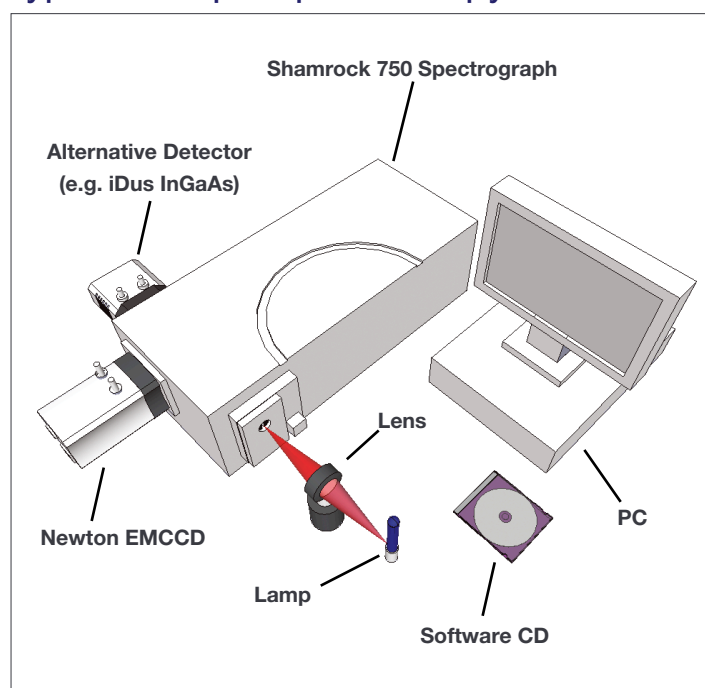

**Figure 1.** Images produced at the exit of the Shamrock 750 with light from a Mercury source (577 and 579 nm lines) and 100  $\mu\text{m}$  core fibre-optic.

- a. Shows elongation of spectral lines when using the standard Shamrock 750 spherical mirrors - well suited to high-resolution, single spectrum acquisition.
- b. Shows demagnification of spectral lines with optional correction optics SR-ASZ-0033 - this allows stacking of multiple spectral channels with minimum vertical cross-talk and with no impact on spectral resolution.

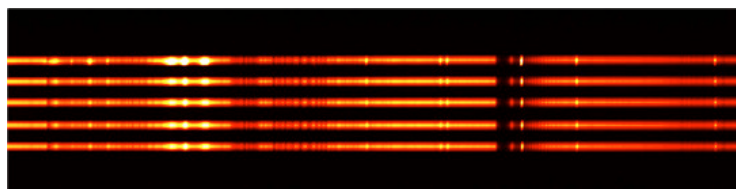

**Figure 2.** Image produced at the exit of the Shamrock 750 with a combination of broadband and Mercury light sources. A 5-way, 100  $\mu\text{m}$  core fibre-optic assembly was used at the entrance of the spectrograph.



## Order Today

Need more information? At Andor we are committed to finding the correct solution for you. With a dedicated team of technical advisors, we are able to offer you one-to-one guidance and technical support on all Andor products. For a full listing of our local sales offices, please see: [andor.com/contact](http://andor.com/contact)

Our regional headquarters are:

### Europe

Belfast, Northern Ireland  
Phone +44 (28) 9023 7126  
Fax +44 (28) 9031 0792

### North America

Connecticut, USA  
Phone +1 (860) 290 9211  
Fax +1 (860) 290 9566

### Japan

Tokyo  
Phone +81 (3) 6732 8968  
Fax +81 (3) 6732 8939

### China

Beijing  
Phone +86 (10) 8271 9066  
Fax +86 (10) 8271 9055

### Items shipped with your spectrograph

- 1x 3 m USB 2.0 cable Type A to Type B
- 1x Power supply with 3 m mains cable
- 1x CD containing Andor user guides
- 1x Individual system performance booklet
- 1x CD containing either Solis software or SDK (if requested at time of order)
- 1x Allen key set (2 mm, 3 mm & 5 mm)

### Regulatory Compliance

Compliant with the requirements of the EU EMC and LVD Directives, compliant with the international EMC and safety standards IEC 61326-1 and IEC 61010-1.

### Footnotes: Specifications are subject to change without notice

1. In the case of a multiple grating turret order, please specify desired grating configuration for each turret.
2. SR-SHT-9002 calls for 1x shutter. For dual input port options (C, D1 & D2) it is recommended to order a shutter for each port. Shutter operation only requires BNC to SMB cable from USB cameras or BNC to BNC cable from IO box for PCI iStar.
3. Typical values quoted with 27.6 mm wide CCD, e.g. Newton DU940.
4. Typical values quoted with 10  $\mu$ m slit and 13.5  $\mu$ m pixel CCD, e.g. Newton DU940.
5. Typical values quoted at 500 nm centre wavelength.
6. Typical values quoted at 300 nm centre wavelength.
7. Typical values quoted at maximum efficiency wavelength or blaze wavelength unless otherwise stated..
8. Wavelength within the recommended operating spectral region.
9. Indicative values; the working range of these gratings is principally in the region where optical aberrations may alter the system resolution performance quoted.
10. Values shown are representative of a triple grating system, where resolution has been Optimized to give the best performance for the three gratings and across the full recommended wavelength range. Useful signal is assumed to be imaged on the entire height of a 6.9 mm sensor (i.e. Newton DU940) and fully vertically binned.
11. Please refer to F/# matcher specification sheet for magnification considerations.
12. Please refer to the local sales representative or website for further information on available options and complimentary accessories.
13. Slit widths range from 10  $\mu$ m to 2.5 mm.
14. For B2 and D2 configurations only - to be ordered separately.
15. Please specify relevant port at time of order.
16. Provided as standard.
17. Recommended for use with fibre-optics and C-mount accessories.
18. Please refer to Shamrock 750 multi-track, imaging technical section for further information.
19. Measured with a 633 nm laser and a 1200 l/mm grating for Full Vertical Binning (FVB) on a 6.9 mm high sensor, and a 1 mm strip vertically centred on the optical axis.
20. Average measurements using > 30 calibration lines, covering the recommended grating angle operating range with a 1200 l/mm grating.
21. The standard deviation of 20 measurements of a peak's centre-of-mass position: between each measurement the drive is moved 10x including both wavelength and grating changes to reflect typical use.
22. Side accuracy measured using a 27.6 mm wide sensor, reflecting the dispersion calibration and step-and-glue accuracy.



### Minimum Computer Requirements:

- 3.0 GHz single core or 2.4 GHz multi core processor
- 2 GB RAM
- 100 MB free hard disc to install software (at least 1 GB recommended for data spooling)
- USB 2.0 High Speed Host Controller capable of sustained rate of 40 MB/s
- Windows (XP, Vista, 7 and 8)

### Operating & Storage Conditions

- Operating Temperature: 0°C to 30°C ambient
- Relative Humidity: < 70% (non-condensing)
- Storage Temperature: -25°C to 50°C

### Power Requirements

- 100 - 240 Vac, 50 - 60 Hz



Windows is a registered trademark of Microsoft Corporation.  
Labview is a registered trademark of National Instruments.  
Matlab is a registered trademark of The MathWorks Inc.